



UNPACKING AND ASSEMBLY

 **concept 2**[®]

DYNAMIC INDOOR ROWER



CONCEPT2 DYNAMIC INDOOR ROWER

Assembly Instructions

Step 1. Open the two boxes and remove all the parts. **Lay out the parts as shown below and read through the assembly instructions before beginning assembly.** Note: The clear plastic shield located on the top of the flywheel is the optional Wind Shield. See Additional Notes for usage on page 9

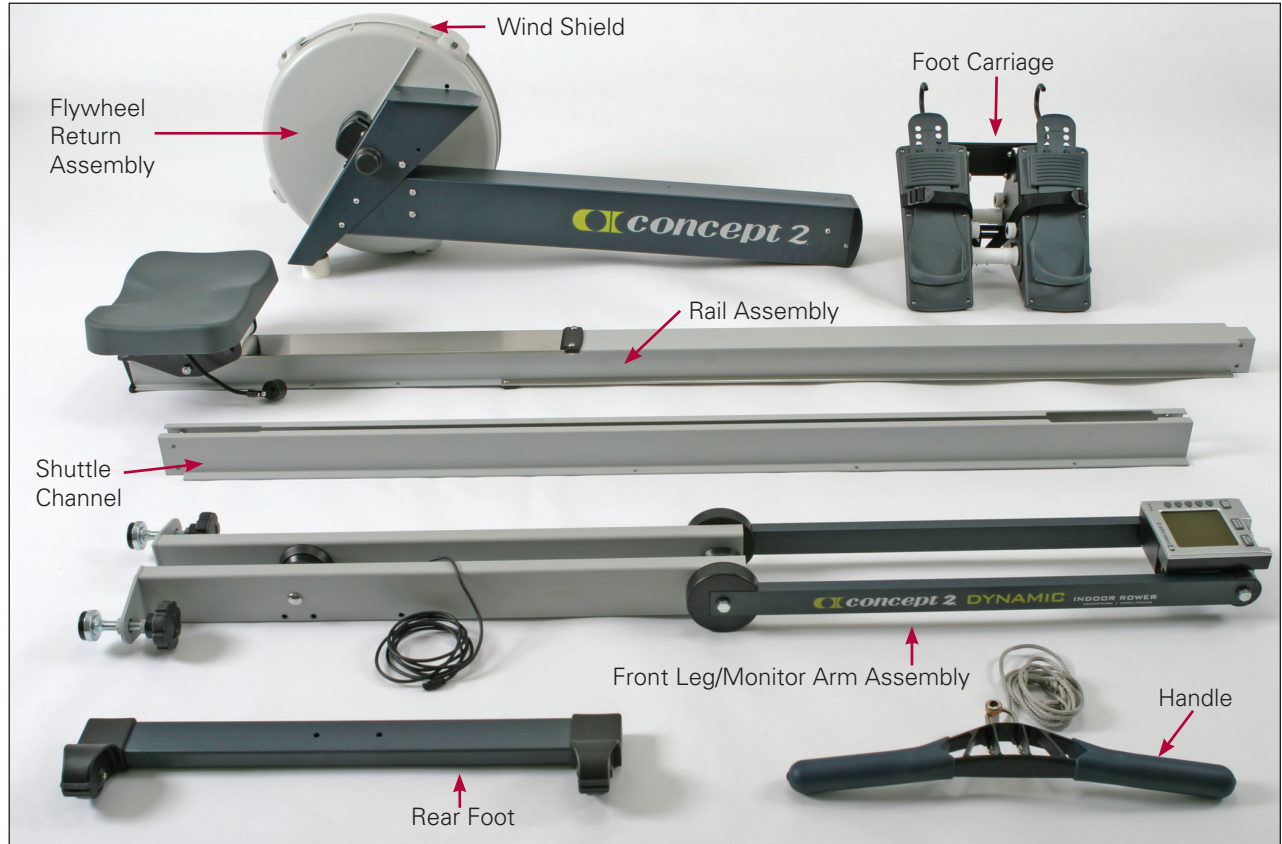

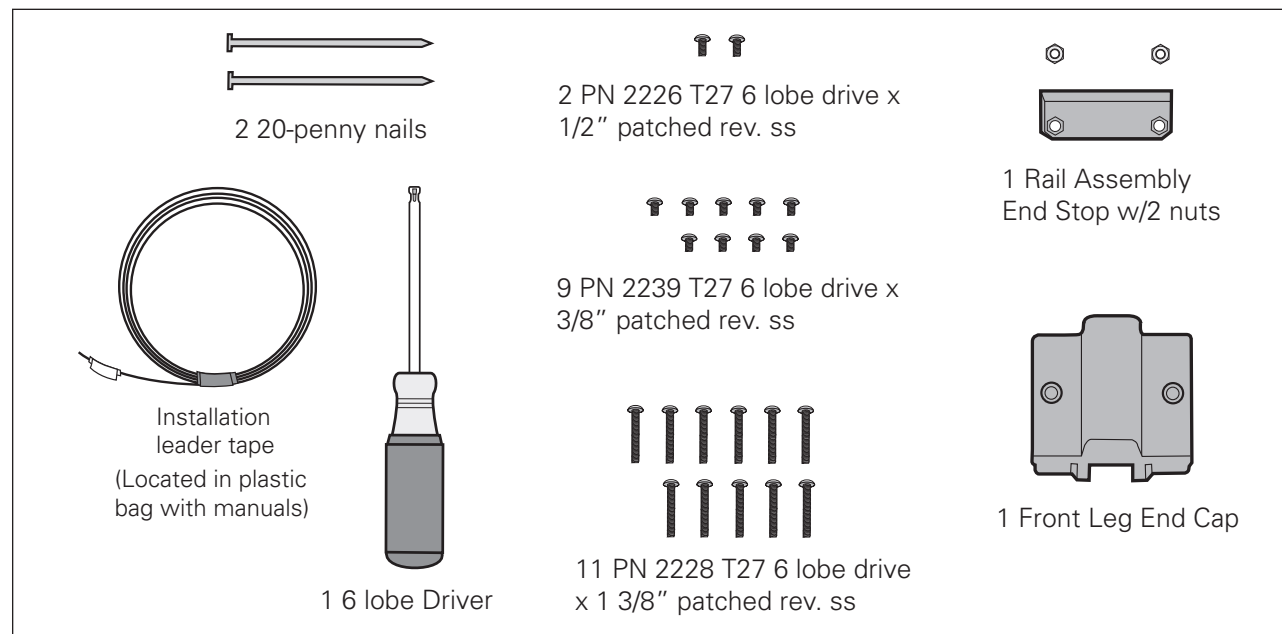

Parts for Assembly



Assembly Instructions

Step 2: Attach Rear Foot to Flywheel Box

Assembly

(2) 3/8" (.95 cm)  
PN 2239

Be sure that caster wheels point back, as shown in the photo of the assembled Dynamic Indoor Rower on page 9. Install the two screws and tighten snugly. See photo A.

photo A



Before turning the flywheel box assembly right side up to continue with assembly, inspect the chain routing over the chain idler pulleys. See image B. The chain should be routed around the chain idler pulleys.

image B

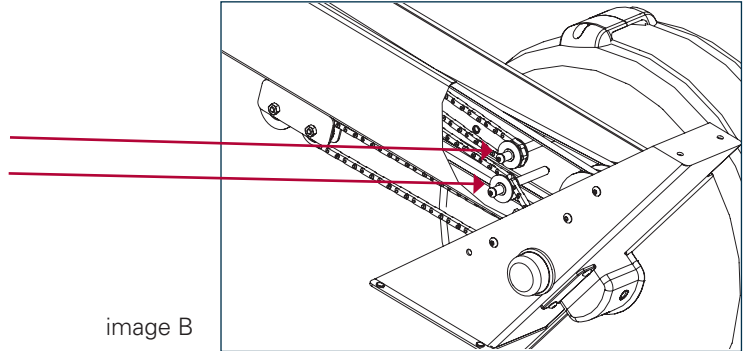



Turn the flywheel box assembly right side up. See photo C.

photo C



Step 3: Install Shuttle Channel

(3) 3/8" (.95 cm)   
PN 2239

Important: Pull shuttle down so that the shuttle lies flat on the return mechanism box.

See photo D.

Remove the cardboard packaging from inside the shuttle channel by sliding it out as indicated by the arrow on the cardboard.

Note: The plastic "floor" remains in the shuttle channel and is adhered at one end only.

Position the shuttle channel with the slot facing up, and the flange to the flywheel side. The end with four holes in it should be away from the flywheel.

photo D



Slide the shuttle channel into the rear leg with the shuttle positioned inside the shuttle channel. See image E.

photo E



Assembly Instructions



Start all three 3/8" screws through the flange of the shuttle channel into the corresponding threaded holes in the return mechanism box. Do not fully tighten the screws until all three screws are in place. See photo F.

photo F



Step 4: Attach Rail Assembly to Flywheel Assembly

Note: It will be helpful to have a second person assist with this step.

(4) 3/8" (.95 cm)    
PN 2239

Place the rail assembly as shown in photo G. Lift the front end of the rail assembly up so that the bottom lies flat against the top of the rear leg.

photo G



Start all four screws into the threaded holes. Do not fully tighten the screws until all four screws are in place. See photo H.

photo H



Step 5: Attach Seat Bungee

(1) 1 3/8" (3.49 cm) 
PN 2228

Insert the screw through the round seat bungee anchor and into the rear leg. See photo I.

Hint: You will need to put tension on the seat bungee to align the screw with the threaded hole.



photo I

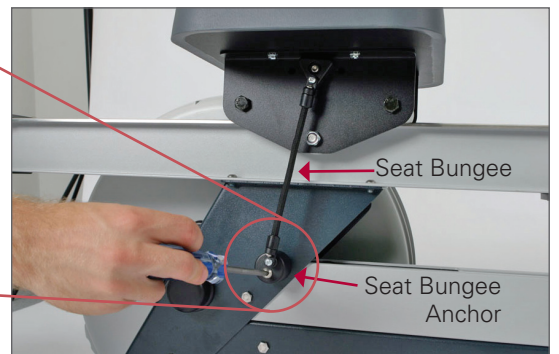

Step 6: Slide Foot Carriage onto Rail Assembly

Slide foot carriage onto rail assembly as shown in photo J. Make sure the drive plate to the foot carriage extends through the slot and into the shuttle channel.

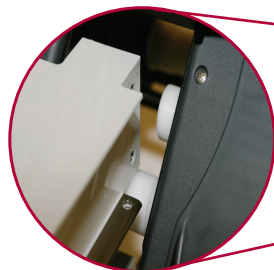
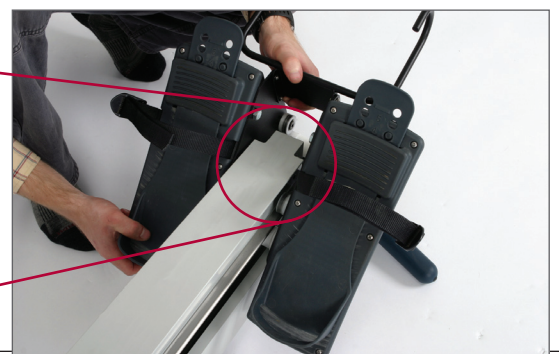

photo J



Assembly continued

Step 7: Install Rail Assembly End Stop

- (2) 1/2" (1.27 cm) PN 2226
- (1) x Rail Assembly end stop w/2 nuts

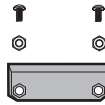

Install the rail assembly end stop on the underside of the rail assembly. Be sure nuts are oriented down toward the floor. See photo K.

photo K

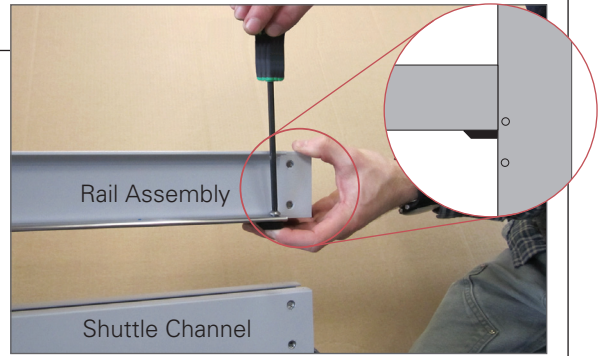

Step 8: Attach Front Leg/Monitor Arm Assembly

- (8) 1 3/8" (3.49 cm) PN 2228

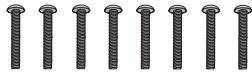

Note: You may need a second person to assist you with aligning the holes.

Position the front leg/monitor arm assembly at end of the shuttle channel and rail assembly. Lift the shuttle channel and rail assembly up with one hand and slide them between the two front legs. See photo L.

photo L

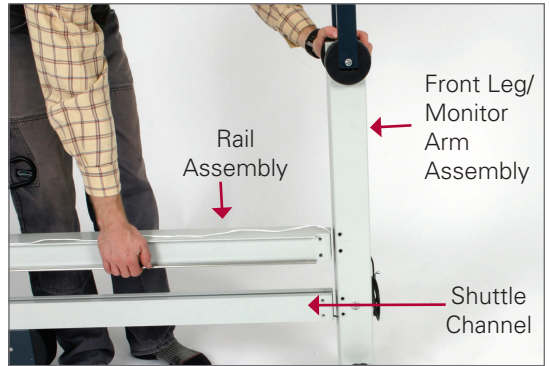

Hint: Insert one 20-penny nail through the top fastener hole into the rail assembly and one 20-penny nail through the top fastener hole into the shuttle channel to temporarily align all fastener holes. Note that these nails will be replaced with the screws. See photo M.

photo M

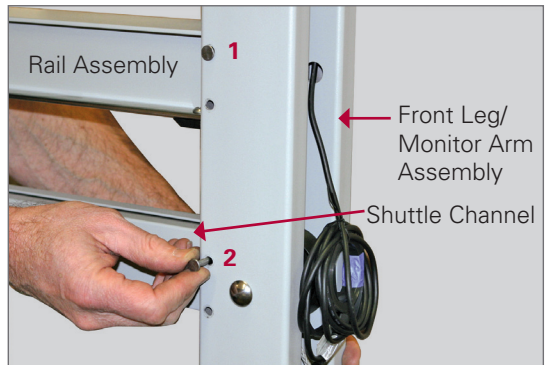

Once you have the parts aligned, insert screws but do not fully tighten until all eight screws are in place. Note that you may need to jostle the rail assembly and shuttle channel to get the screws started. See photo N

photo N



Step 9: Install the Generator Cable

Uncoil the black installation leader tape by removing the blue tape. DO NOT remove the white tape on the end.

At the back end of the rail assembly near the flywheel, feed the white-taped end of the black installation leader tape through the hole in the underside of the rail assembly. See photo O.

photo O



Assembly continued

Feed it all the way through the rail assembly until it comes out the other end. See photo P.

photo P

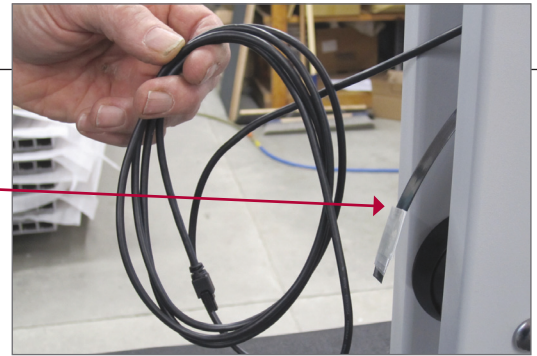

Partially unwrap the white tape and wrap it around the generator cable plug, covering the plug. See photo Q.

photo Q

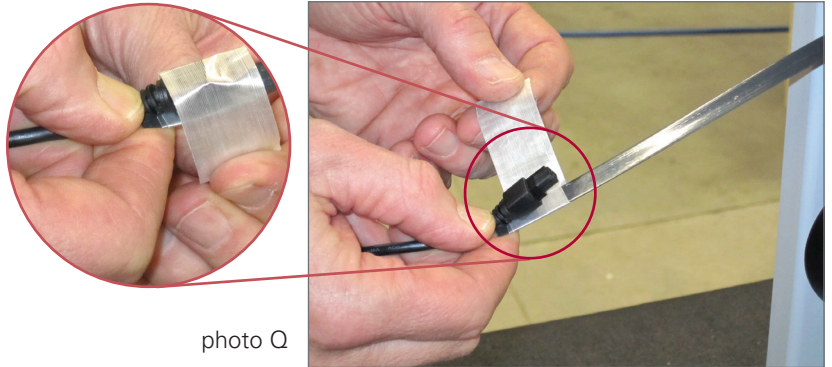

Pull the black installation leader tape (with the generator cable attached) back through the rail assembly until it comes out the hole in the underside of the rail assembly. See photo R.

photo R



Detach the installation leader tape from the generator cable and plug the generator cable into the black generator on the flywheel. See photo S.

Be careful to position so the retainer clip is as shown in the drawing.

Retainer Clip

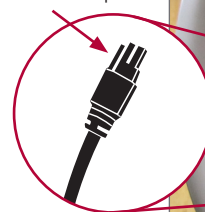
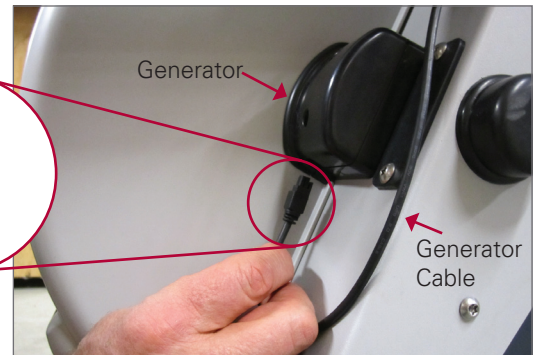

photo S



Step 10: Install the Handle Drive Cord

Push the looped end of the handle drive cord up through the slot in the bottom of the shuttle channel so that it is directly behind the lower pulley. See photo T. Pull all of the handle drive cord out of the top of the shuttle channel and rest it on the floor.

photo T

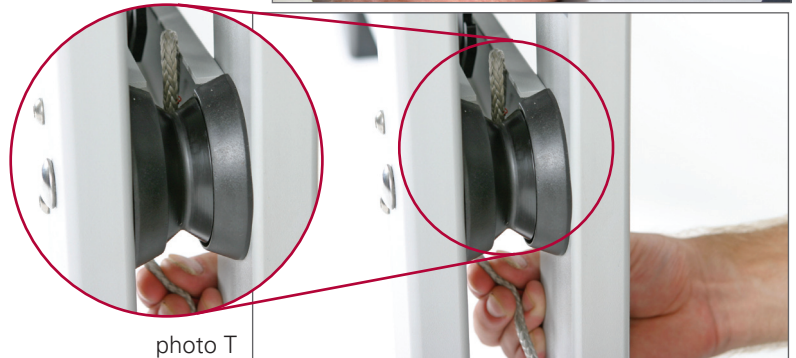

Assembly continued

At the opposite end of the machine where the shuttle channel meets the rear leg, reach into the slot in the shuttle channel and grasp the shuttle. Pull the shuttle up through the slot in the shuttle channel so that it is exposed. See photo U.

photo U



Push the looped end of the handle drive cord up through the shuttle (between the two pulleys) and over the handle drive cord pulley. See photo V.

photo V



Pull the handle drive cord toward the front leg assembly so that all the slack is taken up around the drive cord pulley. See photo W.

photo W



Slide the foot carriage all the way to the end of the rail near the front leg assembly. Hook the looped end of the handle drive cord over the exposed tip of the drive plate hook. See photo X.

photo X



Tuck the handle drive cord down into the slot in the shuttle channel so that the knot of the looped end is inside the shuttle channel and behind the drive plate hook. Pull back on the handle drive cord to ensure that the loop is fully seated at the base of the drive plate hook. Check the knot to ensure it is not rubbing against the top of the shuttle channel. If it is rubbing, remove the loop from the drive plate hook and rotate it so that the tail of the knot is pointing down and away from the top of the shuttle channel. See photo Y.

photo Y

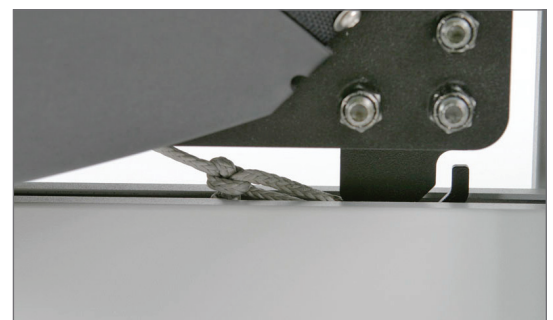

Assembly continued

Step 11: Install Handle Drive Cord and Front Leg End Cap

(2) 1 3/8" (3.49 cm)
PN 2228



Run the handle with drive cord around the top pulley.
See photo Z.



photo Z

Pull the handle toward the foot carriage until it can be placed in the foot carriage handle hook.
See photo Z1.



photo Z1

Insert the front leg end cap over open end of front leg where monitor arm joins the leg. Insert screws all the way until the screw head meets the end cap. Even though the screws will continue to spin, they are as tight as they need to be. See photo Z2.

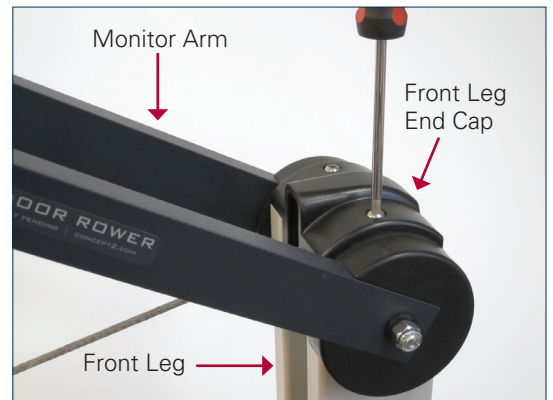

photo Z2

Additional Notes

Setting the Level of the Dynamic Indoor Rower

The Dynamic Indoor Rower should be approximately level for the moving components to work properly. Use the front foot leveling screws to fine tune the level as follows:

Have a friend watch you row:

- If the seat tends to stretch the bungee more to the front of the machine than the rear while rowing, raise the front of the Dynamic Indoor Rower by turning both front foot leveling screws clockwise several turns.
- If the seat tends to stretch the bungee more to the rear of the machine than the front while rowing, lower the front of the Dynamic Indoor Rower by turning both front foot leveling screws counter-clockwise several turns.

Handle Return Tension

The design of the Dynamic Indoor Rower has allowed us to reduce the handle return tension significantly compared to our Model D and E. Handle return tension, inherent in erg rowing, is not something we experience in the boat. We therefore view the lower tension that can be achieved with this design as a positive feature. The tension is set low when we ship the Dynamic Indoor Rower and we suggest rowing with it like this for a while before choosing to tightening the bungee if you really want it to feel "more like an erg." See page 16 of the Dynamic Indoor Rower User Manual for directions.

Wind Shield

The clear plastic Wind Shield located on the top of the flywheel is an optional accessory designed to deflect air coming from the flywheel away from the rower's body. If you prefer the additional breeze, the Wind Shield can be easily removed by bending it slightly and pulling the tabs at either end out of the flywheel enclosures.

Note: Using the Wind Shield will slightly reduce the current drag factor setting, making it feel like you're rowing in a slightly lower damper setting. The flywheel damper may be adjusted as needed to maintain the desired feel. More about damper setting and drag factor can be found at concept2.com.

Maintenance

It is important that some simple steps be taken to ensure the proper working order and quality feel of the Dynamic Indoor Rower.

1. Inspect the drive cord for wear and replace if excessive wear is visible.
2. Clean the seat and rail assembly, including the foot carriage rails, after every workout.
3. Clean and lubricate the chain.

For complete instructions on performing proper maintenance see page 16 of the Dynamic Indoor Rower User Manual.

CONCEPT2 DYNAMIC INDOOR ROWER

